

## WPK légcsatorna ventilátorok

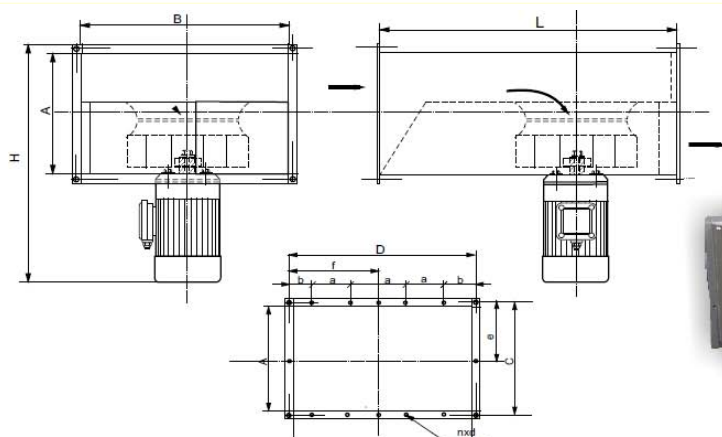

Typ	Wydajność MAX	Wydajność nominalna V		Spręż nom. Δpc	Głośnieść*	Moc silnika	Ilość obrotów	Napięcie zasilania	Masa
	[m <sup>3</sup> /h]	[m <sup>3</sup> /s]	[m <sup>3</sup> /h]	[Pa]	[dB]	[kW]	[obr./min]	[V]	[kg]
WPK-16 A	684	0,08	300	150	63	0,12	2800	230;400	20
WPK-16 B	923	0,17	600	200	70	0,18	2800	230;400	24
WPK-20 A	2100	0,27	1000	200	65	0,25	900	400	52
WPK-20 B	7700	0,94	3200	1200	98	2,20	2800	230;400	85
WPK-25 A	3800	0,69	2500	280	68	0,37	1400	230;400	58
WPK-25 B	7850	1,25	4500	1200	98	2,20	2800	400	67
WPK-25 C	10100	1,75	6200	1300	99	3,00	2800	400	76
WPK-25 D	6000	0,83	4000	415	85	1,10	1400	230;400	51
WPK-31 A	5200	0,83	3000	400	86	0,55	1400	230;400	56
WPK-31 B	9400	2,08	5400	1600	100	5,50	2800	400	143
WPK-35 A	8280	1,34	4850	370	81	1,50	1400	230;400	141
WPK-35 B	12250	2,10	7500	1600	100	7,50	2800	400	182
WPK-35 C	16210	2,63	9470	700	80	4,00	1400	400	189
WPK-40 A	7500	1,52	5470	960	85	3,00	1400	400	167
WPK-40 B	12660	1,82	6580	300	83	1,50	900	400	180
WPK-40 C	22250	3,10	11200	860	93	4,00	1400	400	191

Typ	Wymiary				Koźnierz						
	A	B	L	H	C	D	n x a	b	f	e	n x d
	[mm]	[mm]	[mm]	[mm]	[mm]	[mm]	[mm]	[mm]	[mm]	[mm]	[mm]
WPK-16 A	200	300	440	420	236	336	-	-	168	-	6 x 10
WPK-16 B	200	400	550	420	236	436	-	-	218	-	6 x 10
WPK-20 A	355	700	800	600	391	736	1 x 250	243	-	195,5	10 x 10
WPK-20 B	315	700	800	590	351	736	1 x 250	243	-	175,5	10 x 10
WPK-25 A	315	700	800	550	351	736	1 x 250	243	-	175,5	10 x 10
WPK-25 B	355	700	800	650	391	736	1 x 250	243	-	195,5	10 x 10
WPK-25 C	355	700	800	640	391	736	1 x 250	243	-	195,5	10 x 10
WPK-25 D	500	800	1000	730	536	836	3 x 250	43	-	268	14 x 10
WPK-31 A	355	700	800	680	391	736	1 x 250	243	-	195,5	10 x 10
WPK-31 B	400	800	1000	660	436	836	3 x 250	43	-	218	14 x 10
WPK-35 A	500	1000	1000	900	536	1036	3 x 250	143	-	268	14 x 10
WPK-35 B	500	1000	1000	900	536	1036	3 x 250	143	-	268	14 x 10
WPK-35 C	630	1000	1250	1020	666	1036	3 x 250	143	-	-	16 x 10
WPK-40 A	500	1000	1000	820	536	1036	3 x 250	143	-	268	14 x 10
WPK-40 B	630	1000	1250	1000	666	1036	3 x 250	143	-	-	16 x 10
WPK-40 C	630	1000	1250	1020	666	1036	3 x 250	143	-	-	16 x 10

Charakterystyka aerodynamiczna WPK-16

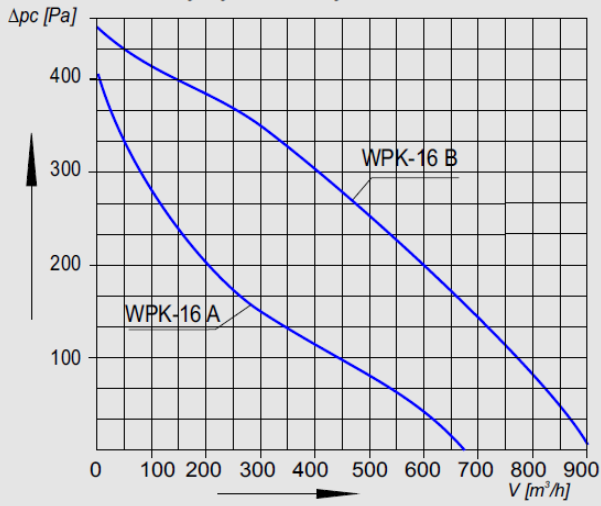

Charakterystyka aerodynamiczna WPK-20,25

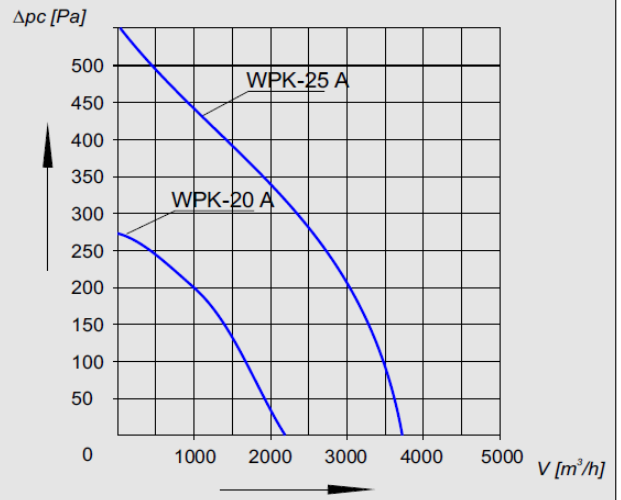

Charakterystyka aerodynamiczna WPK-20, 25

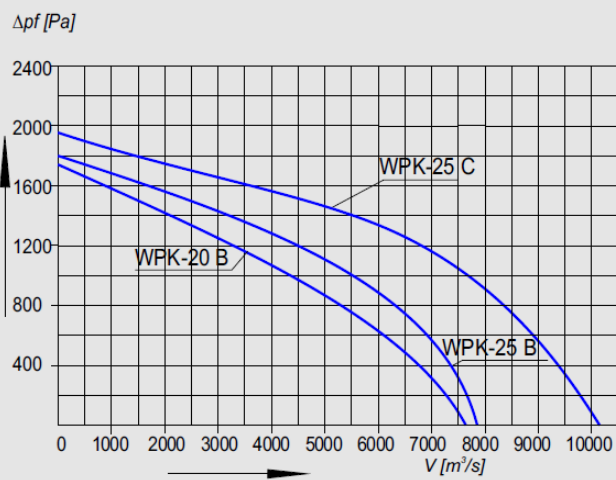

Charakterystyka aerodynamiczna WPK-25D, WPK-31A

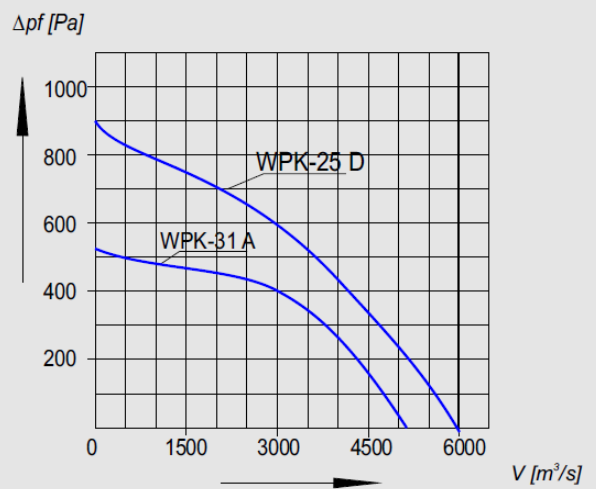

Charakterystyka aerodynamiczna WPK-31B

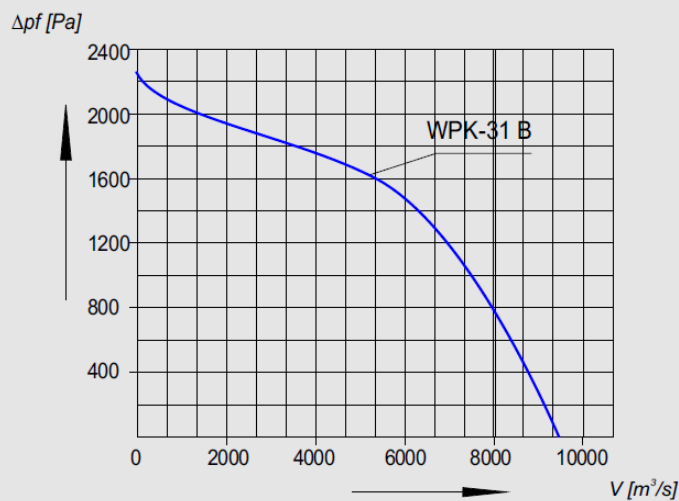

Charakterystyka aerodynamiczna WPK-35

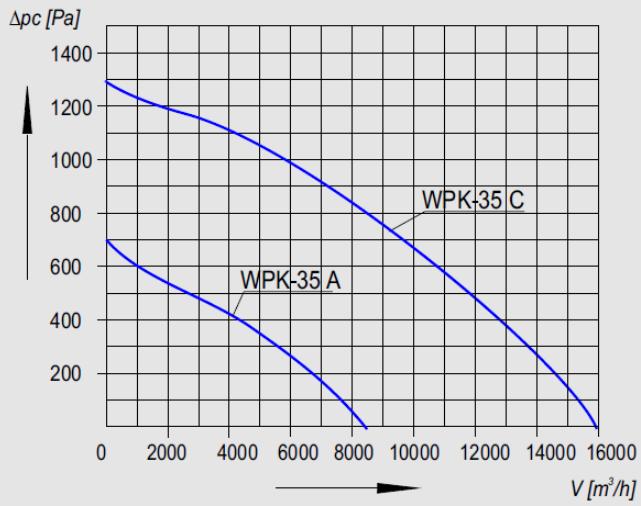

Charakterystyka aerodynamiczna WPK-35 B

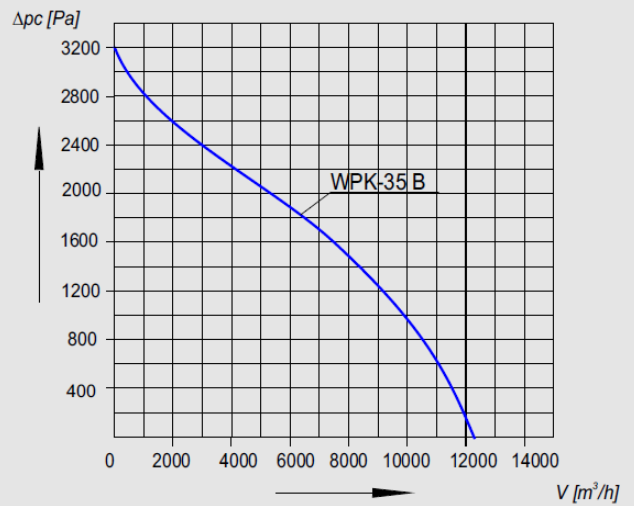

Charakterystyka aerodynamiczna WPK-40 A

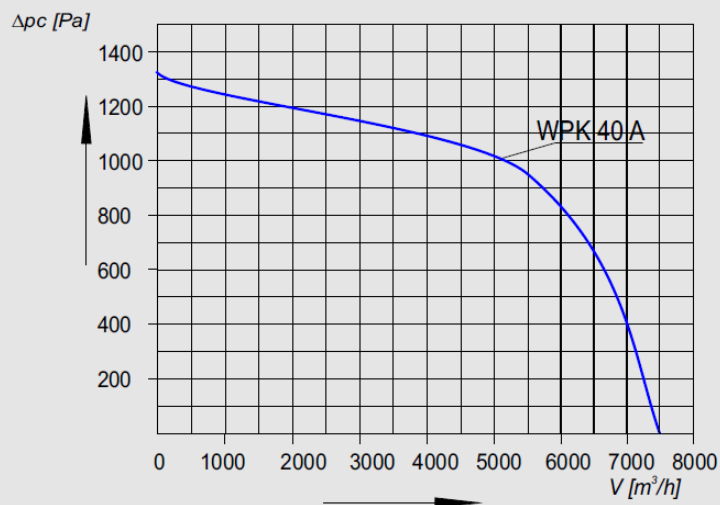

Charakterystyka aerodynamiczna "WPK-40"

